MAGNETS

Permanent Magnetic Material

Alnico • Ceramic

Rare Earth • Flexible

Table of Contents

Introduction

- About **The Magnet Source™** 2
- How to Find the Right Magnet. 3

Permanent Magnet Materials

1. Alnico Magnets

- Information 4 and 5
- Physical Properties Chart 5
- Plugs. 5
- Rods, Bars and Channel Horseshoes 6
- Horseshoes and Holding Magnets 7

2. Ceramic Magnets

- Information 8 and 9
- Physical Properties Chart 9
- Discs. 9
- Blocks and Rings. 10

3. Rare Earth Magnets

- Information 11 and 12
- Physical Properties Chart 12
- Neodymium Rings 12
- Neodymium Blocks and Discs 13
- Samarium Cobalt Rings, Blocks and Discs . . 14

4. High Energy Flexible Magnets

- Information 15
- Physical Properties Chart 15
- Product Chart 15
- Flexible Magnet Pole Patterns 16
- Typical Magnetization Patterns 16

5. Accessories

- Information on Magnetization Patterns 16
- Gaussmeters. 17
- Magnetizers 17
- Magnetic Field Viewing Film 18
- Magnetic Properties Chart 18

Books on Magnetism and Glossary 19

- Other catalogs from **The Magnet Source™** . . . 19

About the company

The Magnet Source™ manufactures and distributes all types of magnetic products for industrial, commercial, and consumer use. Master Magnetics, Inc., the main manufacturing facility located in Colorado, was founded in 1976. **Miami Magnet Company** (founded 1956), **A-L-L Magnetics, Inc.** (1985), and **Master Magnetics East** (1994) joined **Master Magnetics, Inc.**, using the exclusive trade name, **The Magnet Source™**. Today, we serve customers across the U.S. and abroad.

Our large inventory and warehousing capability allow us to serve a wide range of customers with many types of applications. Currently, we have over 15 million magnets in stock. We have excellent resources for raw material magnets and the machinery to cut, grind, and magnetize magnets to meet customer applications. Our other manufacturing capabilities allow us to produce a wide variety of magnetic assemblies. ***We want to be your best source in the magnetic field!***

Three locations to serve you:

U.S.A. and International:

MASTER MAGNETICS, INC.
607 S. Gilbert St., Castle Rock, CO 80104
Toll Free: **888.293.9399**
Local: 303.688.3966

California and Hawaii:

A-L-L MAGNETICS, INC.
2831 Via Martens, Anaheim, CA 92806
Toll Free: **800.262.4638**
Local: 714.632.1754

Southeastern U.S.A.:

MIAMI MAGNET CO.
6073 N.W. 167th St., Ste. C26
Miami, FL 33015
Toll Free: **800.222.7846**
Local: 305.823.0641

Dear Customer:

Thank you for inquiring about our magnetic products. As you will see by this catalog, we have quite a variety of magnets; over 15 million in stock. In order to help you to decide what type of magnet you need, we recommend the following guidelines:

How to find the right magnet

1. **Application** - Describe to us how and what the magnet will be used for. (A mechanical drawing is extremely helpful.) This is the basis for all further questions.
2. **Material** - There are several types of magnet material available, which include flexible (rubber) magnets, ceramic (strontium ferrite), alnico (Al Ni Co), samarium cobalt (Sm Co), and neodymium (Nd Fe B). Within each material group there are various grades. Each section in this catalog describes the characteristics and common applications of these materials. Most of these raw material magnets are used in OEM applications.
If your application calls for lifting, holding, retrieving, or separating ferrous metal items, then you may need a magnetic assembly (featured in our Magnetic Devices catalog). Magnetic assemblies are constructed from raw material magnets, which are combined with other components to meet a specific application.
3. **Strength** - The application will determine the strength of the magnet that you will need. Raw material magnets are rated by either mega-gauss oersteds, or more commonly, gauss. In

the raw material magnets table of characteristics on page 18 you can see the difference in strength among material. Magnetic assemblies, in contrast, are usually rated by pounds of pull.

4. **Shape** - Does your application require a specific shape of magnet? Most magnets are made in standard symmetrical shapes such as rings, discs, blocks, rods, and bars. Some types of magnets are machinable.
5. **Size** - Does your application require specific tolerances? Will the magnet be visible in your application? Our magnet tolerances are in accordance with Magnetic Materials Producers Association (MMPA) standards. For more information on MMPA see page 19.
6. **Magnetization** - What does your application require (see page 16)? A magnet can be magnetized through the thickness, length, or even diameter depending on the magnet's orientation. Or it can be magnetized with multiple poles [more than one pair of North/South poles] on one face of the magnet, or on both sides. Some magnets are limited in the ways they can be magnetized. The purpose for various magnetization patterns is to alter the magnet's strength to best fit its application.
7. **Quantity** - How many will you need now? How many will you need over a year's time?

Sincerely,

The Magnet Source Team



Founding Members of:



Alnico Magnets

Alnico magnets are made primarily from aluminum, nickel, cobalt, copper, iron, and sometimes titanium. They can be either cast or sintered.

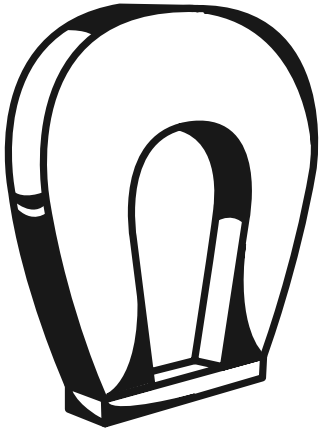

Cast Alnico

Cast alnico is melted and poured into a mold. Once solidified, the material is rough ground and then heat-treated and cooled, sometimes in a magnetic field. When treated in the presence of a magnetic field, the magnet is called anisotropic. This orients the material to take on maximum magnetization and allows a higher gauss level. A cast magnet that is not heat-treated in a magnetic field is called isotropic. After heat treatment and cooling, the material can be ground to specific tolerances and then magnetized.

Attributes of Cast Alnico

- Size parameters range from 1 ounce to about 70 pounds
- Will cast to a variety of shapes and sizes

Sintered Alnico

Sintered alnico is made from a powdered mixture of ingredients that are pressed into a die under tons of pressure, sintered in a hydrogen atmosphere and then cooled either within a magnetic field or without (anisotropic vs. isotropic).

Attributes of Sintered Alnico

- Size parameters range from about one ounce of material up to one cubic inch
- Pressed to close tolerance/minimal grinding to finish
- Mechanically strongest of alnicos

Attributes of Both Cast and Sintered Alnico

- Very temperature stable, great for high heat applications
- Maximum working temperature 975° - 1020° F
- May be ground to size
- Does not lend itself to conventional machining (hard and brittle)
- High residual induction and energy product compared to ceramic material
- Low coercive force compared to ceramic and rare earth materials (more subject to demagnetization)
- Most common grades of alnico are 5 and 8

Applications of Alnico Magnets

Magnets, separators, sensors, electron tubes, traveling wave tubes, radar, holding magnets, coin acceptors, clutches and bearings, motors, distributors, relays, controls, generators, receivers, telephones, microphones, bell ringers, guitar pickups, loudspeakers, security systems, cow magnets.

Tolerances

Unless otherwise specified, our tolerances on alnico material meet and often exceed Magnet Materials Producers Association (MMPA) standards. Information on MMPA Standards pamphlet is available on page 19.

For unfinished surfaces (as cast) the following tolerances apply:

0-1" ± .016	1-3" ± .031	3-5" ± .047
5-7" ± .062	7-9" ± .078	9-12" ± .094

Alnico Magnets (continued)

Finished surfaces are normally ground to $\pm .005$
(See MMPA standards for more details.)

Magnetizing and Handling

Magnetizing is done after the magnet has been machined to the correct tolerances. Care should be taken when handling alnico material since it is brittle and can chip or break if dropped on a hard surface. Also, because it has a low resistance to demagnetization, it will lose power if it is stored improperly (poles

repelling each other). For best results, store magnetized alnico so that pieces are attracting each other, or with a steel keeper.

Machining

Alnico is a very hard and brittle material and does not lend itself to conventional machining. **The Magnet Source™** employs experienced machinists and the proper equipment to grind alnico to its required dimensions.

Typical Magnetic and Physical Properties of Alnico Magnet Material

Anisotropic Alnico	Density		Maximum Energy Product BH(max)	Residual Induction Br	Coercive Force Hc	Intrinsic Coercive Force (Hci)	Maximum Operating Temperature		Curie Temperature	
	lbs/in ³	g/cm ³	MGO	Gauss	Oersteds	Oersteds	F°	C°	F°	C°
Alnico 5 (cast)	0.264	7.3	5.5	12800	640	640	975	525	1580	860
Alnico 8 (cast)	0.262	7.3	5.3	8200	1650	1860	1020	550	1580	860
Alnico 5 (sintered)	0.250	6.9	3.9	10900	620	630	975	525	1580	860
Alnico 8 (sintered)	0.252	7.0	4.0	7400	1500	1690	1020	550	1580	860

Alnico Plugs

Part No.	Weight/lbs.	Dimensions in Inches	
		Diameter	Thickness
10001	0.043	0.689	0.430
10002	0.063	0.759	0.522
10003	0.092	0.840	0.626
10004	0.092	0.908	0.535
10005	0.198	1.114	0.765
10006	0.425	1.151	0.970

Tolerances: $\pm .005$ on all dimensions. All dimensions approximate.

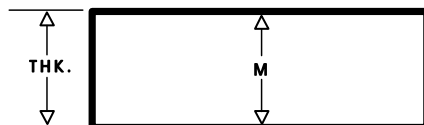
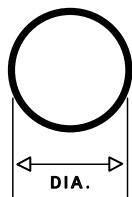

Oriented through thickness (M)



Alnico Rods

Diameter	Length in Inches														Weight Lbs./inch
	3/8	1/2	5/8	3/4	1	1-1/4	1-1/2	1-3/4	2	3	4	5	6	8	
1/8	•	•	•	•	•	•	•	•	•	•	•	•	•	N/A	0.0033
3/16	•	•	•	•	•	•	•	•	•	•	•	•	•	N/A	0.0074
1/4	•	•	•	•	•	•	•	•	•	•	•	•	•	•	0.0135
5/16	N/A	•	N/A	•	•	•	•	•	•	•	•	•	•	•	0.0202
3/8	N/A	•	N/A	•	•	•	•	•	•	•	•	•	•	•	0.0305
1/2	N/A	•	N/A	•	•	•	•	•	•	•	•	•	•	•	0.0520
7/8	N/A	N/A	N/A	N/A	•	•	•	•	•	•	•	•	•	•	0.1587
1	N/A	N/A	N/A	N/A	•	•	•	•	•	•	•	•	•	•	0.2073

Key: N/A = not available in this size. All dimensions approximate.
Tolerances: 0 - .5" dia. are ground on O.D. to $\pm .005$ and cut to length $\pm .010$ and .875 - 1" dia. are as cast on O.D. to $\pm .016$ and $\pm .031$ respectively and cut to length $\pm .031$. Standard stock items listed above are cast Alnico 5 material. Other grades and lengths may be available upon request.

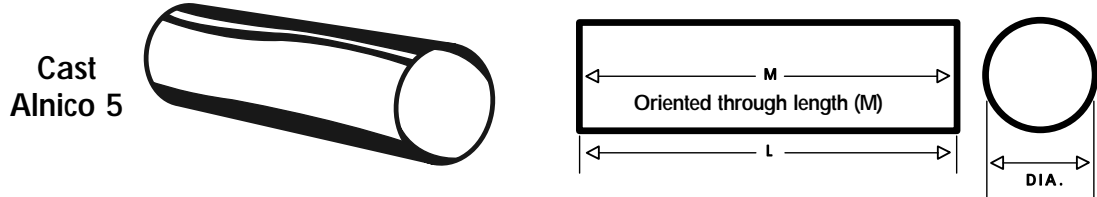

Alnico Bars

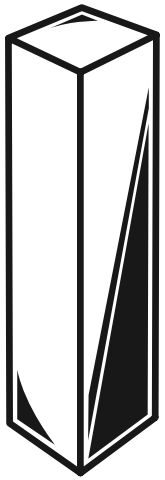

Cast Alnico 5

Thickness x Width (inches)	Length in Inches											Weight lbs/inch
	1/2	3/4	1	1-1/4	2	3	4	5	6	8	10	
1/4 x 1/4	•	•	•	•	•	•	•	•	•	•	•	0.0167
1/4 x 1/2	•	•	•	•	•	•	•	•	•	•	•	0.0333
1/4 x 1	N/A	N/A	•	•	•	•	•	•	•	•	N/A	0.0667
3/8 x 1	N/A	N/A	•	•	•	•	•	•	•	•	•	0.0999
1/2 x 1/2	N/A	N/A	•	•	•	•	•	•	•	•	•	0.0667
1/2 x 1	N/A	N/A	N/A	N/A	•	•	•	•	•	•	•	0.1333
3/4 x 3/4	N/A	N/A	N/A	N/A	•	•	•	•	•	•	N/A	0.1490
1 x 1	N/A	N/A	N/A	N/A	•	•	•	•	•	•	N/A	0.2650

Key: N/A = not available in this size. All dimensions approximate.
Tolerances: As cast - 0" - 1" $\pm .016$ and cut to length $\pm .010$, and 1" - 2" $\pm .031$ and cut to length $\pm .031$. Standard stock items listed above are cast Alnico 5 material. Other grades and lengths may be available upon request.

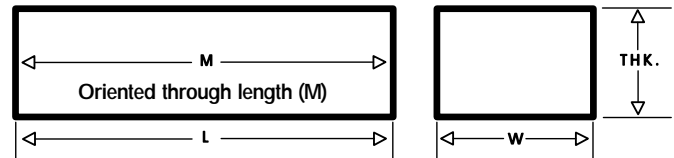

Alnico Channel Horseshoes

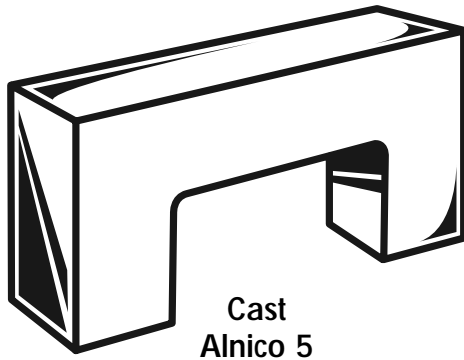

Cast Alnico 5

Part No.	Wgt. Lbs.	Lbs. Pull	Dimensions in Inches					
			A	B	C	D	E	F
ACH1945	.007	0.5	0.500	.312	.187	.156	.125	.187
ACH79	.031	1.0	0.790	.445	.364	.189	.245	.412
ACH1950	.153	12.0	1.500	.875	.500	.500	.312	.500

All dimensions approximate and as cast with pole faces ground smooth. Other sizes may be available upon request. **Note:** Part No. ACH1945 is available in up to 5" lengths along the "C" dimension. Part No. ACH1950 is available in up to 6" lengths. Part No. ACH79 - all surfaces are ground smooth.

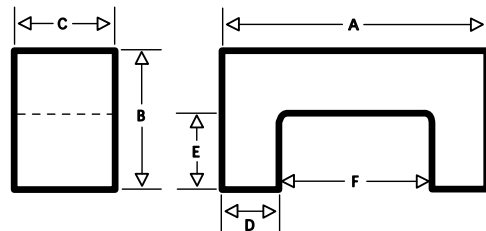

Alnico Horseshoes

Part No.	Wgt. Lbs.	Lbs. Pull	Dimensions in Inches					
			A	B	C	D	E	F
HS170 •	0.063	3	0.750	1.125	0.250	0.312	0.219	1.125
HS3702 •	0.200	13	1.125	0.750	0.750	0.750	0.250	1.125
HSPH2	0.067	1	1.188	1.950	0.250	0.400	0.400	1.188
HS244	0.138	15	1.250	1.250	0.437	0.375	0.437	1.500
HS90	0.2840	19	1.625	0.844	1.125	0.812	0.406	1.625
HS537 •	0.283	22	1.625	1.562	0.625	0.375	0.625	1.812
HS171	0.292	22	2.000	1.375	0.609	0.750	0.625	2.000
HS286	0.922	60	2.500	2.500	0.750	1.000	0.750	3.000
HSPH1 *	0.950	3	3.000	3.750	0.750	2.100	0.500	3.000

Key: • = Magnet is painted red and has a keeper.

* = Magnet is painted black with North pole marked and has a keeper.

Made of 3-1/2% chrome.

All dimensions approximate and as cast with pole faces ground smooth.

Other sizes may be available on request.

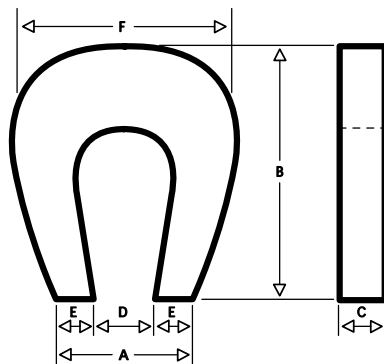

Cast
Alnico 5

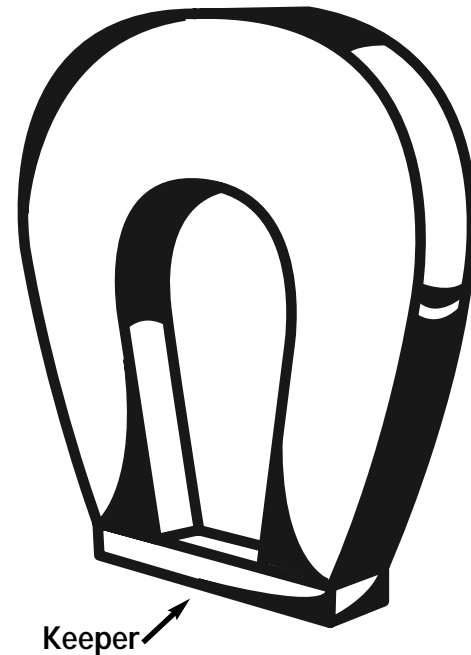

Alnico Holding Magnets

Part No.	Wgt. Lbs.	Lbs. Pull	No. of Poles	Dimensions in Inches				
				A	B	C	D	E
AH2E821 •	0.020	1.5	2	0.500	0.375	0.156	0.281	0.171
AH25H153	0.052	5.0	2	0.687	0.687	0.344	0.344	1.187
AH23131	0.042	4.0	2	0.750	0.500	0.250	0.375	0.218
AH2CU511	0.172	6.0	2	0.875	0.625	0.280	0.375	0.219
AH2888	0.101	9.0	2	0.875	0.875	0.437	0.406	0.250
AH2823C •	0.083	6.0	2	1.000	0.625	0.343	0.343	0.218
AH43136	0.102	16.0	4	1.000	0.750	0.250	0.500	0.250
AH2225	0.344	23.0	2	1.250	1.375	0.687	0.531	0.312
AH63130	0.163	25.0	6	1.250	0.750	0.250	0.625	0.250
AH2CU512	0.172	11.0	2	1.250	0.750	0.312	0.500	0.187
AH63133	0.270	30.0	6	1.500	0.875	0.312	0.750	0.375
AH83140	0.702	65.0	8	2.000	1.250	0.375	1.000	0.500

Key: • = Painted red and has a keeper.

All dimensions approximate and as cast with pole faces ground smooth.

Other sizes may be available on request.

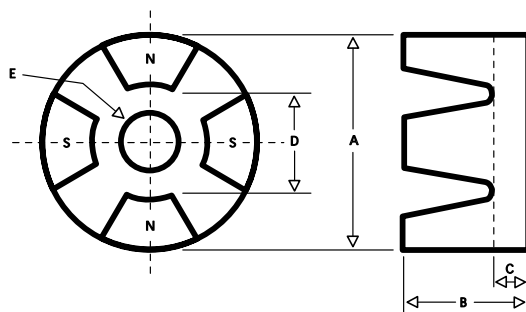

2 Pole

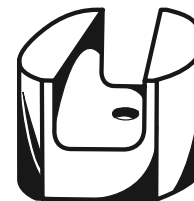

4 Pole



6 Pole

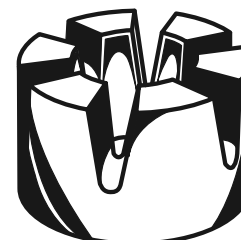

Cast

Alnico 5
888.293.9399

Ceramic Magnets

Ceramic (ferrite) magnets are composed of strontium carbonate and iron oxide. They are charcoal gray in color and usually appear in the forms of discs, rings, blocks, cylinders, and sometimes arcs for motors.

Manufacturing Ceramic Magnets

A powdered mixture of strontium carbonate and iron oxide is injected into either a wet press or a dry press for forming. During this pressing process, a magnetic field is applied in the direction of preferred magnetization to orient the material and increase the magnet's performance potential. This magnet is considered "oriented." If not exposed to a magnetic field at time of formation, it is called "non-oriented" (isotropic).

After the molding process, the material is then sintered at about 2000°F. This process is similar to that of kilning ceramic pottery, thus the popular name "ceramic" magnet.

Lastly, the magnet is finish-ground to size with a diamond-bladed grinding wheel, magnetized, and inspected for shipment.

Attributes of Ceramic Magnets

- High intrinsic coercive force
- Tooling is expensive
- Least expensive material compared to alnico and rare earth magnets
- Limited to simple shapes due to manufacturing process
- Lower service temperature than alnico, greater than rare earth
- Finishing requires diamond cutting or grinding wheel
- Lower energy product than alnico and rare earth magnets

- Most common grades of ceramic are 1, 5 and 8 (1-8 possible)
- Grade 8 is the strongest ceramic material available

Applications of Ceramic Magnets

- Speaker magnets
- DC brushless motors
- Magnetic Resonance Imaging (MRI)
- Magnetos used on lawnmowers, and outboard motors
- DC permanent magnet motors (used in cars)
- Separators (separate ferrous material from non-ferrous)
- Used in magnetic assemblies designed for lifting, holding, retrieving, and separating

Tolerances

Pressed dimensions are either $\pm 2\%$ or $\pm .025$ whichever is greater. Cut dimensions are either $\pm 3\%$ or $\pm .025$, whichever is greater. Thickness tolerances are normally ground to $\pm .005$.

Visual imperfections such as cracks, porosity, voids, surface finish, etc. (commonly found in sintered ceramic magnets) do not constitute cause for rejection. According to the MMPA standards specification pamphlet (see page 19), "Chips shall be acceptable if no more than 5%... of the pole surface is removed." And that, "Cracks shall be acceptable, provided they do not extend across more than 50%... of the pole surface."

Magnetizing and Handling

Ceramic magnet material is extremely brittle and can chip or break if dropped on a hard surface, or if allowed to "jump at" an attracting object. Handle with care.

The weakest grade of ceramic material is grade 1, which is typically non-oriented. Grades 5 and 8 are oriented ceramic material. Grade 8 is the strongest

Ceramic Magnets (continued)

ceramic magnet material available (Refer to properties chart below).

When making magnetic assemblies with ceramic, it is typically easier for production purposes to magnetize the product after assembly.

Machining

Since ceramic material is so brittle, it requires special machining techniques and equipment. We are fully equipped to cut and grind ceramic material to your specifications.

Typical Magnetic and Physical Properties of Ceramic Magnet Material

Ceramic Material	Density		Maximum Energy Product	Residual Induction	Coercive Force	Intrinsic Coercive Force (Hci)	Normal Maximum Operating Temperature		Curie Temperature	
	lbs/in ³	g/cm ³	MGO	Gauss	Oersteds	Oersteds	F°	C°	F°	C°
Ceramic 1	0.177	4.9	1.05	2300	1860	3250	842	450	842	450
Ceramic 5	0.177	4.9	3.4	3800	2400	2500	842	450	842	450
Ceramic 8	0.177	4.9	3.5	3850	2950	3050	842	450	842	450

Ceramic Discs

Part No.	Grade	Dimensions in Inches		Approx. Weight
		Diameter	Thickness	
CD06	1	0.187	0.187	0.0008#
CD002500	5	0.250	0.281	0.0025#
CD312	5	0.312	0.125	0.0017#
CD003500	5	0.350	0.250	0.0043#
CD02	1	0.375	0.125	0.0024#
CD0225	1	0.375	0.250	0.0046#
CD12	5	0.375	0.410	0.0079#
CD13	5	0.460	0.400	0.0116#
CD14N	8	0.472	0.197	0.0060#
CD04	1	0.492	0.187	0.0062#
CD004900	5	0.496	0.138	0.0048#
CD031	5	0.500	0.100	0.0034#
CD15	5	0.500	0.180	0.0062#
CD005000	5	0.500	0.230	0.0081#
CD6212	5	0.562	0.125	0.0056#
CD0625	1	0.625	0.125	0.0064#
CD0625/2P	1	0.625	0.125	0.0064#
CD25J	5	0.625	0.375	0.0201#
CD10CAT	8	0.701	0.197	0.0133#
CD10N	8	0.701	0.197	0.0137#
CD10J	5	0.709	0.197	0.0136#
CD007100	5	0.710	0.200	0.0143#
CD710	5	0.710	0.250	0.0173#
CD75MP	1,MP	0.750	0.250	0.0193#
CD07	1	0.750	0.250	0.0193#
CD0787	1	0.787	0.156	0.0126#
CD9	5	0.787	0.156	0.0133#
CD8-2P	5	0.800	0.395	0.0347#
CD20N	8	0.866	1.000	0.1052#
CD0875MP	1	0.875	0.120	0.0121#
CD970N	8	0.970	0.156	0.0202#
CD970	5	0.970	0.156	0.0202#
CD985MP	1,MP	0.985	0.200	0.0267#
CD010000	5	1.000	0.625	0.0884#
CD010002	5	1.000	0.250	0.0353#
CD108	1	1.080	0.236	0.0004#
CD150	1,MP	1.500	0.187	0.0580#

Key: 1 = Grade 1 ceramic, 5 = Grade 5 ceramic, 8 = Grade 8 ceramic (strongest ceramic material available), MP = Multiple poles on surface. All dimensions approximate.

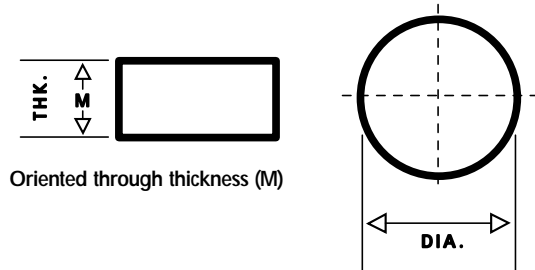
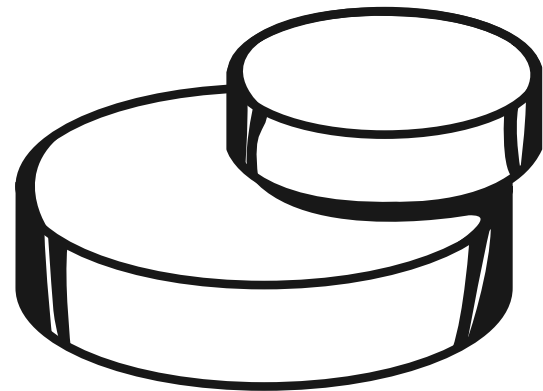

Ceramic Blocks

Part No.	Grade	Dimensions in Inches			Approx. Weight	Part No.	Grade	Dimensions in Inches			Approx. Weight
		Thickness	Width	Length				Thickness	Width	Length	
CB2	1	0.078	0.354	0.669	0.0031#	CB124	1	0.250	0.500	1.000	0.021#
CB100071	5	0.120	0.406	0.875	0.0059#	CB60CATMAG	5	0.393	0.875	1.875	0.1100#
CB1274	1	0.125	0.750	1.930	0.030#	CB60-2P	5	0.393	0.875	1.875	0.1128#
CB1911C8	8	0.125	2.000	3.000	0.131#	CB60/2	5	0.393	0.875	0.925	0.0573#
CB3	5	0.187	0.250	0.875	0.007#	CB65	5	0.393	0.430	1.875	0.046#
CB41ST	5, H ₁	0.187	0.750	1.000	0.025#	CB60/2 ^H	5, 2 ^H	0.393	0.875	1.875	0.098#
CB41IP	5	0.197	0.750	0.984	0.0248#	CB702	5, 8	0.500	1.000	2.000	0.1750#
CB40	1, H ₀	0.197	0.750	1.000	0.025#	CB70	5, 8	0.500	1.000	6.000	0.525#
CB29	5	0.214	0.750	2.500	0.070#	CB802	5, 8	0.500	2.000	3.000	0.525#
CB2301	5	0.230	0.230	1.000	0.0093#	CB80	5, 8	0.500	2.000	6.000	1.050#
CB1435	5	0.236	0.354	1.180	0.017#	CB85	8	0.500	4.000	6.000	2.100#
CB240	5	0.240	0.765	1.959	0.0629#	CB95	5	0.750	4.000	6.000	3.150#
CB246	5	0.240	0.622	1.960	0.051#	CB187	5, 8	1.000	1.000	6.000	1.050#
CB247	5	0.240	0.787	1.960	0.065#	CB1862	5, 8	1.000	2.000	2.000	0.700#
CB31	5	0.250	0.250	3.000	0.033#	CB1863	5, 8	1.000	2.000	3.000	1.050#
CB1434	5	0.250	0.375	0.750	0.012#	CB186	5, 8	1.000	2.000	6.000	2.100#
CB14342	5	0.250	0.375	1.500	0.025#	CB188	5, 8	1.000	3.000	4.000	2.100#
CB219	5, 8	0.250	2.000	3.000	0.263#	CB184	5	1.000	3.000	6.000	3.150#
CB219X2	8	0.250	2.000	6.000	0.525#	CB185	5, 8	1.000	4.000	6.000	4.200#

Key: 1 = Grade 1 ceramic, 5 = Grade 5 ceramic, 8 = Grade 8 ceramic (strongest ceramic material available), H₀ = .197" hole, H₁ = has a .1875" hole through the middle, 2^H = has 2 holes 3/16" dia., 1" center to center. All dimensions approximate.

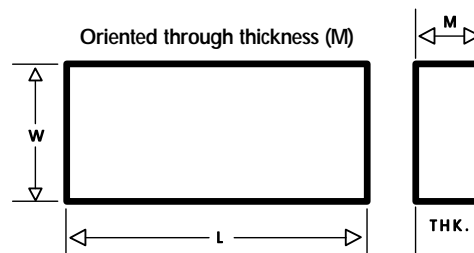
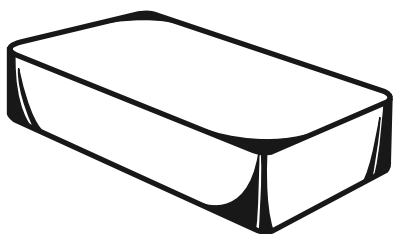

Ceramic Rings

Part No.	Grade	Dimensions in Inches			Approx. Weight	Part No.	Grade	Dimensions in Inches			Approx. Weight
		Outer Diameter	Inner Diameter	Thickness				Outer Diameter	Inner Diameter	Thickness	
CR552282	5	0.550	0.228	0.200	0.0071#	CR45	5	1.770	0.866	0.314	0.103#
CR551209078	8	0.551	0.197	0.078	0.0029#	CR250N	5	2.360	1.140	0.331	0.1998#
CR551209098	8	0.551	0.197	0.098	0.0037#	CR238128	5	2.380	1.000	0.280	0.185#
CR10N	8	0.689	0.296	0.118	0.0065#	CR280	5	2.800	1.203	0.330	0.290#
CR74RMX	5	0.745	0.250	0.392	0.0270#	CR337A	5	3.376	1.280	0.425	0.570#
CR75	1	0.750	0.250	0.250	0.0170#	CR337C	5	3.376	1.280	0.850	1.140#
CR106	1	1.060	0.216	0.125	0.0190#	CR454A	5	4.540	1.750	0.400	0.965#
CR120	1	1.125	0.750	0.125	0.0120#	CR525A	5	5.250	1.910	0.550	1.811#
CR119811	1	1.181	0.983	0.115	0.0065#	CR525N	5	5.275	2.240	0.550	1.811#
CR145	5	1.250	0.375	0.187	0.0370#	CR525CN	5	5.275	2.240	0.750	2.290#
CR154	5	1.550	0.882	0.224	0.0514#	CR700R	5	7.500	3.250	0.750	4.710#
CR175	5	1.750	0.875	0.225	0.0710#						
CR162	1	1.750	1.280	0.250	0.0467#						

Key: 1 = Grade 1 ceramic, 5 = Grade 5 ceramic, 8 = Grade 8 ceramic (strongest ceramic material available). All dimensions approximate.

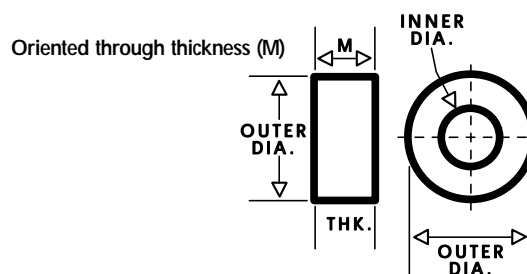
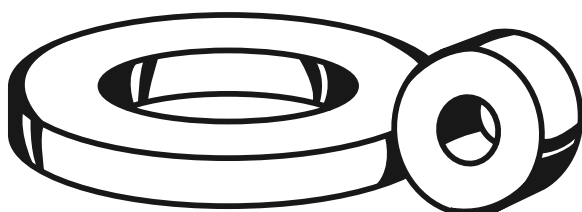

Rare Earth Magnets

Neodymium magnets (Nd-Fe-B) are composed of neodymium, iron, boron and a few transition metals. Samarium cobalt magnets (SmCo) are composed of samarium, cobalt and iron. These rare earth magnets are extremely strong for their small size, metallic in appearance and found in such simple shapes as rings, blocks and discs.

Manufacturing Rare Earth Magnets

In general, the elements are melted together and milled into a powder that is dry-pressed to shape in the presence of a magnetic field. The material is then sintered, aged, ground to dimension, magnetized and tested. They are called "rare earth" magnets because the elements of neodymium and samarium are classified as such in the lanthanides section of the Periodic Table of the Elements.

Neodymium

Attributes of neodymium

- Very high resistance to demagnetization
- High energy for size
- Good in ambient temperature
- High priced
- Material is corrosive and should be coated for long term maximum energy output
- Low working temperature for heat applications

Applications of Neodymium

Magnetic separators, linear actuators, microphone assemblies, servo motors, DC motors (automotive starters), computer rigid disc drives, hammerbank printers, and speakers.

Samarium

Attributes of Samarium

- High resistance to demagnetization
- High energy
(magnetic strength is strong for its size)
- Good temperature stability
- Expensive material
(cobalt is market price sensitive)

Applications of Samarium

- Computer disc drives
- Sensors
- Traveling wave tubes
- Linear actuators
- Satellite systems
- Motors where temporary stability is vital

Rare Earth Tolerances

For as pressed material, tolerance on the thickness (direction of magnetization) is $\pm .005$. Other dimensions are $\pm 2.5\%$ or $\pm .010$, whichever is greater.

According to Magnet Materials Producers Association (MMPA) standards, visual imperfections such as hairline cracks, porosity and minor chips are commonly found in sintered metallic magnets. A chipped edge is considered acceptable if no more than 10% of the surface is missing. Cracks are acceptable as long as they do not extend across more than 50% of pole surface (*information on the MMPA standards pamphlet is on page 19*).

Rare Earth Magnetizing and Handling

Rare earth magnets are very brittle and very strong magnetically. Therefore, it is crucial to handle these magnets with extreme care to avoid personal injury and damage to the magnets. Fingers can be severely pinched between attracting magnets. Magnets can chip if allowed to "jump at" an attracting object. It is highly recommended that when constructing rare earth magnetic assemblies, they be magnetized after assembly.

Rare Earth Magnets (continued)

Rare Earth Machining

Since rare earth magnet material is prone to chipping and cracking, it does not lend itself to conventional machining methods. It can, however, be

abrasively ground, but only with the use of liberal amounts of coolant. The coolant minimizes heat fracturing and the risk of fires caused by oxidized grinding dust.

Typical Magnetic and Physical Properties of Rare Earth Magnet Material

Rare Earth Material	Density		Maximum Energy Product BH(max)	Residual Induction Br	Coercive Force Hc	Intrinsic Coercive Force (Hci)	Maximum Operating Temperature		Curie Temperature	
	lbs/in ³	g/cm ³					F°	C°	F°	C°
SmCo 18	0.296	8.2	18.0	8700	8000	20000	482	250	1382	750
SmCo 20	0.296	8.2	20.0	9000	8500	15000	482	250	1382	750
SmCo 24	0.304	8.4	24.0	10200	9200	18000	572	300	1517	825
SmCo 26	0.304	8.4	26.0	10500	9000	11000	572	300	1517	825
Neodymium 27	0.267	7.4	27.0	10800	9300	11000	176	80	536	280
Neodymium 27H	0.267	7.4	27.0	10800	9800	17000	212	100	572	300
Neodymium 30	0.267	7.4	30.0	11000	10000	18000	176	80	536	280
Neodymium 30H	0.267	7.4	30.0	11000	10500	17000	212	100	572	300
Neodymium 35	0.267	7.4	35.0	12300	10500	12000	176	80	536	280

Neodymium Rings

Part No.	Grade in MGO	Dimensions in Inches			Approx. Weight/Lbs
		Outer Diameter	Inner Diameter	Thickness	
NR152N-27	27	0.375	0.125	0.060	0.00157
NR152-27	27	0.375	0.125	0.060	0.00157
NR009-27	27	0.472	0.250	0.374	0.01258
NR741N-30	30	0.745	0.450	0.100	0.00739
NR754137-27	27	0.750	0.410	0.375	0.03104
NR788405325-27	27	0.788	0.405	0.325	0.03114
NR2002N-27	27	2.000	1.750	0.375	0.07309

NOTE: A second "N" in the part number indicates nickel plating.
All dimensions are approximate.
Other sizes and grades may be available on request.

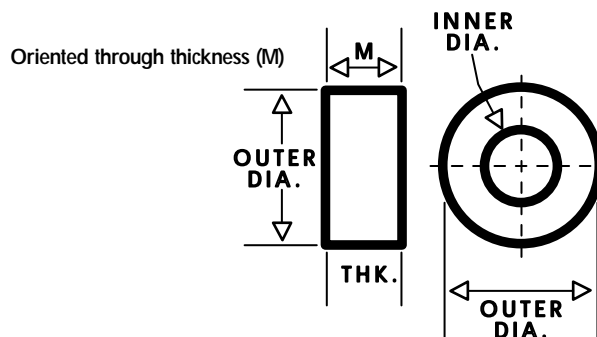
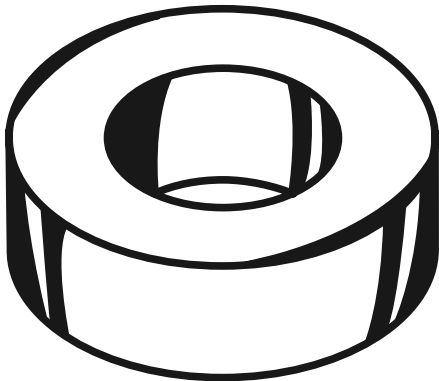

Neodymium Blocks

Part No.	Grade in MGO	Dimensions in Inches			Approx. Weight/Lbs.
		Thickness	Width	Length	
NB045-27	27	0.045	0.101	0.200	0.0002
NB0781547N-27	27	0.074	0.153	0.467	0.0014
NB11325N-27	27	0.100	0.130	0.250	0.0008
NB12525N-27	27	0.100	0.250	0.250	0.0016
NB112660N-27	27	0.110	0.260	0.600	0.0045
NB15321-27	27	0.150	0.320	1.000	0.0128
NB1818375N-35	35	0.188	0.188	0.375	0.0035
NB188S375N-35	35	0.188	0.188	0.375	0.0354
NB30N-35 •	35	0.230	0.230	0.750	0.0106
NB239646-30	30	0.234	0.391	0.469	0.0115
NB25575-27	27	0.250	0.500	0.750	0.0250
NB502575-30	30	0.500	0.250	0.750	0.0250
NB50502N-30	30	0.500	0.500	2.000	0.1340
NB006N-27	27	0.500	1.000	1.000	0.1340
NB006N-30H	30H	0.500	1.000	1.000	0.1340
NB006N-35	35	0.500	1.000	1.000	0.1340
NB058-27	27	0.500	2.000	2.000	0.534
NB058N-30	30	0.500	2.000	2.000	0.534
NB147N-30 •	30	1.000	2.000	2.000	1.068

Key: H = Higher heat capacity • = Available with or without nickel plating.

NOTE: A second "N" in the part number indicates nickel plating.

Other sizes and grades may be available on request.

All dimensions approximate.

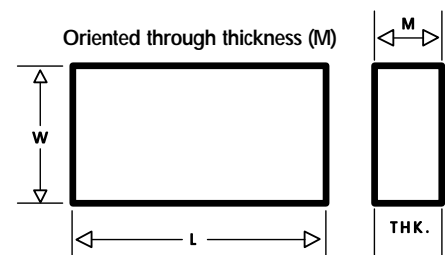
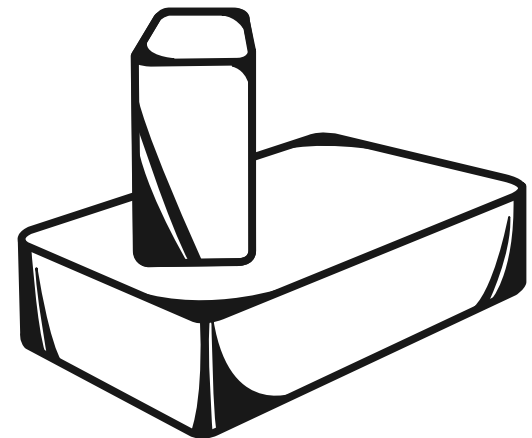

Neodymium Discs

Part No.	Grade in MGO	Dimensions in Inches		Approx. Weight/Lbs.
		Diameter	Thickness	
ND118197-27	27	0.118	0.197	0.00058
ND12525N-27	27	0.125	0.250	0.00082
ND18703-27	27	0.187	0.030	0.00221
ND308N-27	27	0.187	0.060	0.00044
ND18725N-27	27	0.187	0.250	0.00184
ND022N-27	27	0.197	0.059	0.00048
ND146N-27	27	0.250	0.100	0.00131
ND146N-30	30	0.250	0.100	0.00131
ND146N-35	35	0.250	0.100	0.00131
ND145N-27	27	0.250	0.200	0.00262
ND283N-27	27	0.250	0.250	0.00328
ND060N-27	27	0.375	0.100	0.00296
ND144N-27	27	0.375	0.200	0.00592
ND187N-27	27	0.375	0.250	0.00740
ND2012N-27	27	0.375	0.375	0.01106
ND381-35	35	0.375	1.000	0.02949
ND103N-27	27	0.500	0.125	0.00655
ND140N-27	27	0.500	0.200	0.01052
ND143N-27	27	0.500	0.250	0.01320
ND151N-27	27	0.500	0.500	0.02621
ND501-35	35	0.500	1.000	0.05243
ND6006N-27	27	0.750	0.100	0.01181
ND064N-30	30	0.750	0.187	0.02211
ND142N-27	27	0.750	0.375	0.04423
ND050-27	27	0.866	0.393	0.06200
ND040-27	27	0.875	0.450	0.07225
ND048N-27	27	0.875	1.000	0.16055
ND048-27H	27H	0.875	1.000	0.16055
ND048N-35	35	0.875	1.000	0.16055
ND105-27	27	1.000	0.187	0.03921
ND105-30	30	1.000	0.187	0.03921
ND125N-27	27	1.000	0.250	0.05243
ND150N-27	27	1.000	0.375	0.07864
ND150Z-35	35	1.000	0.375	0.07864
ND025-27	27	1.000	0.500	0.10510
ND030N-27	27	1.000	0.750	0.15738

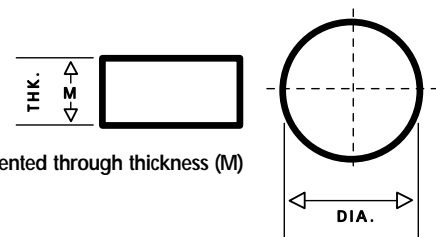
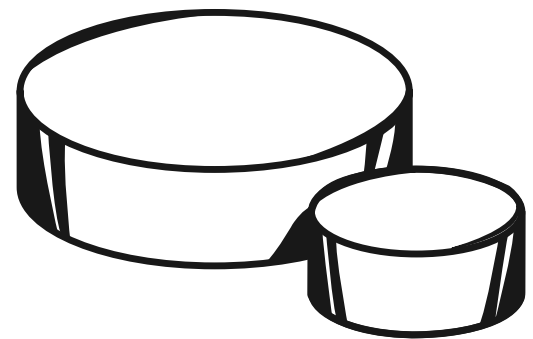

Key: H = Higher heat capacity

• = Available with or without nickel plating.

NOTE: A second "N" in the part number indicates nickel plating.

Tolerances: ± .020 on diameter, + .005 on thickness.

Other sizes and grades may be available on request.

All dimensions approximate.

Samarium Cobalt Rings

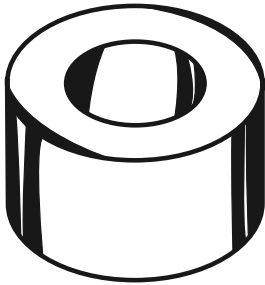

Part No.	Grade in MGO	Dimensions in Inches			Approx. Weight/Lbs
		Outer Diameter	Inner Diameter	Thickness	
SCR006600	18	0.669	0.492	0.100	0.0048
SCR754325-18	18	0.750	0.437	0.250	0.02161

All dimensions approximate. Other sizes and grades may be available on request.

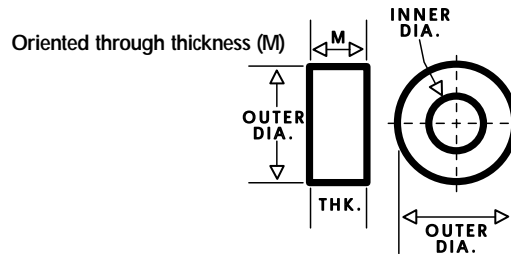

Samarium Cobalt Blocks

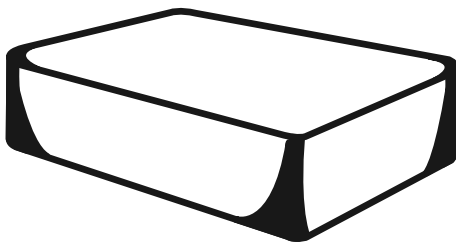

Part No.	Grade in MGO	Dimensions in Inches			Approx. Weight/Lbs
		Thickness	Width	Length	
SCB2543775-18	18	0.250	0.437	0.750	0.0250
SCB250	22	0.250	0.500	1.000	0.0380
SCB260	18	0.260	0.260	0.125	0.0025
SCB400	24	0.500	0.550	2.000	0.165
SCB500	18	0.500	2.000	2.000	0.5920

All dimensions approximate. Other sizes and grades may be available on request.

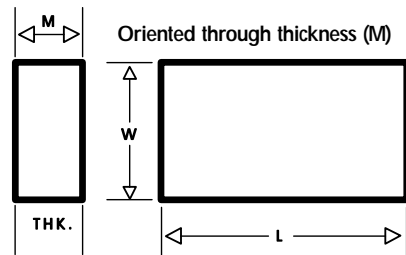

Samarium Cobalt Discs

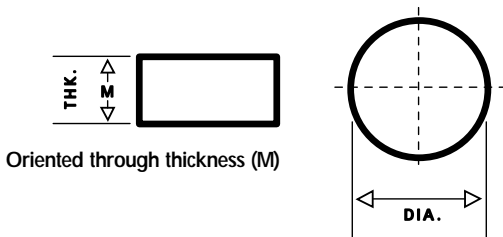
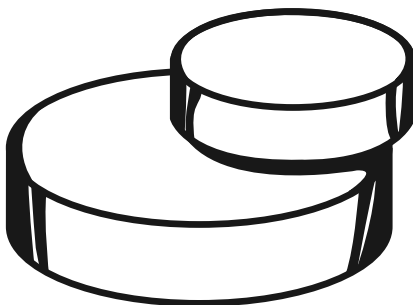

Part No.	Grade in MGO	Dimensions in Inches		Approx. Weight/Lbs.
		Diameter	Thickness	
SCD118N	20	0.118	0.118	0.00038
SCD156	18	0.156	0.060	0.00034
SCD157	18	0.156	0.077	0.00043
SCD187	18	0.187	0.060	0.00048
SCD188	18	0.187	0.080	0.00065
SCD25	18	0.250	0.100	0.00145
SCD26	18	0.250	0.125	0.00181
SCD2525	18	0.250	0.250	0.00363
SCD375	18	0.375	0.125	0.00408
SCD3751	18	0.375	0.060	0.00196
SCD3752	18	0.375	0.250	0.00817
SCD475	18	0.475	0.440	0.02307
SCD500	18	0.500	0.060	0.00348
SCD518	18	0.500	0.187	0.01086
SCD625	24	0.625	0.060	0.00559

NOTE: Part number SCD118N, SCD188, and SCD25 are nickel plated.

Tolerances: ± .020 on diameter, ± .005 on thickness.

Other sizes and grades may be available on request.

All dimensions approximate.

High Energy Flexible Magnets

High-Energy Flexible Magnets are composed of a strontium ferrite powder mixture with polymer bonding. These magnets are most commonly found in the forms of strip and sheeting.

Manufacturing High Energy Flexible Magnets

The material goes through a calendaring process and is formed into sheeting or strip. It can then be easily machined to size and magnetized. High-energy flexible magnets are anisotropic (oriented), whereas the regular flexible material is not. Therefore, high-energy magnets are limited to magnetization through the thickness, and are similar in strength to a Grade 1 ceramic magnet.

Attributes of High Energy Flexible Magnets

- High resistance to demagnetization
- Easy fabrication and handling
- Free from chipping, cracking or shattering
- Inexpensive
- High energy product vs. regular flexible material
- Adhesive or plain
- Low curie point, not good in heat applications

Applications of Flexible Magnets

- Motors
- Sensors
- Latches
- Magnetic Assemblies

Please refer to our flexible magnet catalog for information on our selection of regular flexible magnet materials.

Typical Magnetic and Physical Properties of High Energy Flexible Magnets

High Energy Flexible Material (BH Max)	Density		Maximum Energy Product MGO	Residual Induction Br Gauss	Coercive Force Hc Oersteds	Intrinsic Coercive Force (Hci) Oersteds
	lbs/in ³	g/cm ³				
1.1	0.128	3.542	1.10	2200	1900	2400
1.2	0.128	3.542	1.20	2300	1950	2400
1.3	0.128	3.542	1.30	2350	2000	2900
1.4	0.128	3.542	1.40	2450	2100	2900

Part No.	Dimensions in Inches				Magnetization	Max. Energy Product (BH Max)
	Thickness	Width	Length	Diameter		
PSM10	0.060	0.50	48	-	2 P.E.S.	1.1
PSM2-060-1DIAMP	0.060	-	-	1.0	MP	1.2
PSM1-80CONV	0.060	2.00	1200	-	Conv.	1.1
PSM2-125-1X1.25CONV	0.125	1.00	1.25	-	Conv.	1.2
PSM2-125-1X1.625CONV	0.125	1.00	1.625	-	Conv.	1.2
PSM2-125-.5X8.11ACMP	0.125	0.50	8.11	-	2 P.E.S.	1.2
PSM30	0.125	0.50	48	-	2 P.E.S.	1.1
PSM3-125-60	0.125	2.00	60	-	Conv.	1.3
PSM50	0.125	3.00	24	-	MP	1.1
PSM4-125-4X5CN	0.125	4.00	60	-	Conv.	1.4
PSM3-187-.25CP	0.187	0.25	0.50	-	Conv.	1.3
PSM4-187-4X5CN	0.187	4.00	60	-	Conv.	1.4
PSM1-250	0.250	0.50	60	-	Conv.	1.1
PSM4-250-1X1CONV	0.250	1.00	1.0	-	Conv.	1.4
PSM1-250-3X36C	0.250	3.00	36	-	Conv.	1.1
RR-RB20 (with .187" hole)	0.125	-	-	1.1250	Conv.	1.1
RD8125	0.125	-	-	0.8125	MP	1.1
RD162MP	0.125	-	-	1.6200	MP	1.1
RUB40 (with .1875" hole)	0.187	0.75	1	-	Conv.	1.1

Key: Conv. = Conventional, 2 P.E.S. = Two poles each side, MP = Multiple poles. See page 16 to view Flexible Magnet Pole Patterns

Flexible Magnet Pole Patterns

A. Conventional Magnetization: has one pole on each side of the magnet. North pole on one side, South pole on the other.

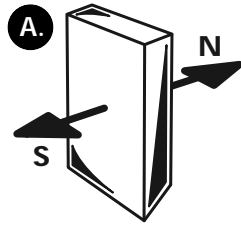

B. Multiple Pole (Standard): Multiple Poles (B1) or Two Poles (B2) on each side; two or more sets of poles on each surface are used in open circuit designs. North and South poles alternate through the thickness of the material. Steel backing is desirable where practical.

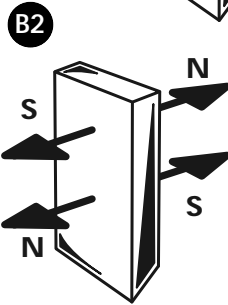
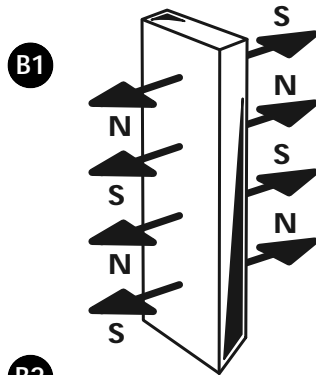

Typical Magnetization Patterns

Oriented (anisotropic) materials: have better magnetic properties in a given direction. During the manufacturing process, a magnetic field is applied in the direction of preferred magnetization to orient the material and increase the magnet's performance potential. With oriented material, multiple pole magnetization flux goes "through" the magnet making both sides of the magnet strong.

Non-oriented (isotropic) materials: Have equal magnetic properties in all directions. During the manufacturing process the magnet is not exposed to a magnetic field. This material can be magnetized in any magnetization pattern. This material is weaker than oriented materials. With non-oriented material, multiple pole magnetization flux bends inside the magnet making it strong on one side only.

The following magnetization patterns apply to both oriented and non-oriented magnet materials.

Bars - Through the length - Magnetized North at one end and South at the other.

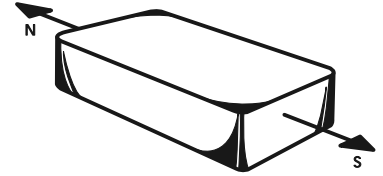

Rods - Through the length or axial - Magnetized North on one end and South on the other.

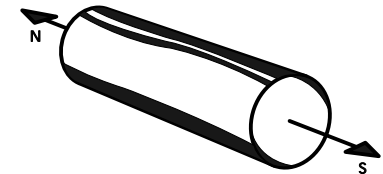

Blocks - Through the thickness - Magnetized North on one side of the thickness and South on the other.

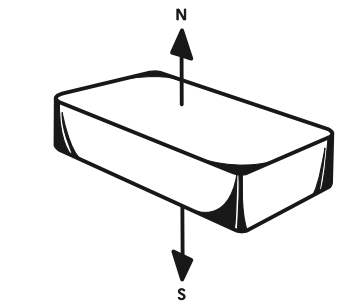

Disc or Ring - Through the thickness - Magnetized North on one face of the disc and South on the other.

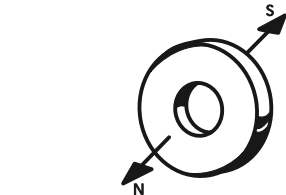

Bar or Block - Through the width or across the width - Magnetized North on one side of width and South on the other.

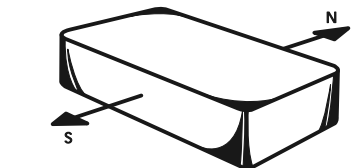

Discs - Multiple poles (two sets or more) on a surface magnetized through the thickness - Magnetized with more than one set of N/S poles on one or both faces of the magnet.

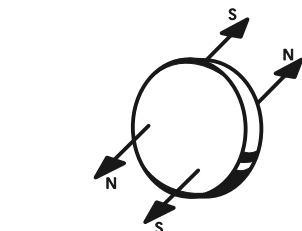

Gaussmeters • Magnetizers

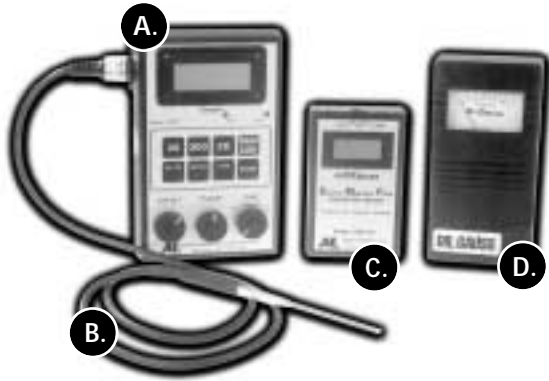

Micropower Gaussmeter (Part No. GM1A)

A. GM1A - This hand-held instrument provides for the accurate (.25% of reading, \pm one digit), quick (self-calibrating) and convenient (3.5 digit LED display) measurement of DC magnetic fields. Both flux density in gauss and polarity are shown. Use GM1A for magnet quality, classification and sample testing (9 volt battery included). This unit accepts a variety of pre-calibrated transverse, axial, bare and magnetometer probes (sold separately).

B. GM1APT70 - Standard transverse probe is used to measure magnetic polarity and gauss.

Electro-Magnetic Field Meters (EMF)

Wherever there is an electric current, there is a corresponding EMF. Due to the increasing concern, but inconclusive evidence regarding health effects of Electro-Magnetic Fields (AC powerline - radiated EMFs), we have models available for use in detecting and minimizing exposure.

C. EMF931 - This hand-held 5 ounce model measures EMFs with $\pm 1\%$ accuracy at 60Hz and has a reading range of .1 milligauss to 1000 milligauss that appears on its LED crystal display (9 volt battery included).

D. EMF860R - (DR. GAUSS™) This hand-held 6 ounce model measures EMFs with relative accuracy and has a reading range of .1 milligauss to 10 milligauss, that appears on its needle display.

play. A built-in audio signal is emitted when a field is detected and intensifies as the gauss level increases (9 volt battery not included).

Magnetizers

The following magnetizing forces are recommended by magnet manufacturers for various magnetic materials, expressed in Amp/turns required per inch of length of magnet material:

Alnico 1,2,3	4000 Amp / turns / inch
Alnico 5,6	6000 Amp / turns / inch
Alnico 8, 9	10,000 Amp / turns / inch (varies by grade)
Ceramic	20,000 Amp / turns / inch

SmCo and NdFeB require capacitor discharge units.



Self-Contained Magnetizer (Part No. MAG24C)

Capacity	24,500 Amp / turns
Size	10-1/8" L x 5-1/8" W x 7-9/16" H
Weight	40 lbs.
Will Magnetize .	Alnico 5 up to 2" x 3" long and ceramic 5 up to 2" x 2-1/2" long. Typically used to magnetize alnico.

Connects to standard 120 VAC (50/60 Cycles, 14 Amps) outlet. Adjust tapered pole shoes (up to 4" gap) to fit magnet length. Place magnet or assembly between poles and depress switch for one second. Repeating the cycle does not increase magnetization.

Magnetic Field Viewing Film

Magnetic Field Viewing Film

Use this amazing film to view the location and number of poles on any magnet. Magnetic poles appear as dark areas and the light areas represent where North and South poles meet. This material is available in large sheets which may be cut to size, or in a durable laminated card size.

Part No. Description

- MVP1 12" x 12" sheet of field viewing film
MVP2 18" x 36" sheet of field viewing film
DMVC-1 . . . 2-1/2" x 4" laminated field viewer card (shown right)

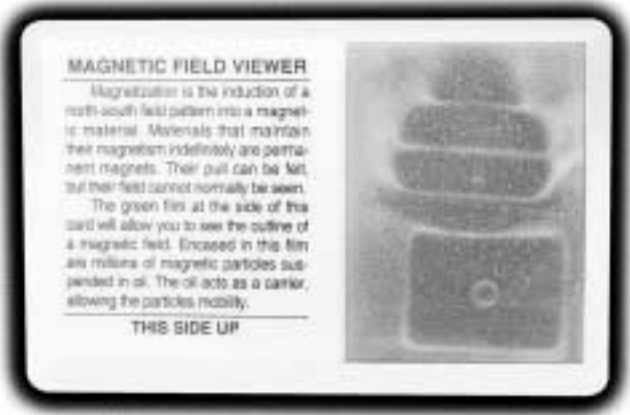

Typical Magnetic and Physical Properties of Magnet Material

Magnetic Material	Density		Maximum Energy Product BH(max) MGO	Residual Induction Br Gauss	Coercive Force Hc Oersteds	Intrinsic Coercive Force Hci Oersteds	Normal*		Curie Temperature	
	lbs/in ³	g/cm ³					Maximum Operating Temperature	F°	C°	F°
Anisotropic Alnico										
Alnico 5 (cast)	0.264	7.3	5.5	12800	640	640	975	525	1580	860
Alnico 8 (cast)	0.262	7.3	5.3	8200	1650	1860	1020	550	1580	860
Alnico 5 (sintered)	0.250	6.9	3.9	10900	620	630	975	525	1580	860
Alnico 8 (sintered)	0.252	7.0	4.0	7400	1500	1690	1020	550	1580	860
Ceramic Material										
Ceramic 1	0.177	4.9	1.05	2300	1860	3250	842	450	842	450
Ceramic 5	0.177	4.9	3.4	3800	2400	2500	842	450	842	450
Ceramic 8	0.177	4.9	3.5	3850	2950	3050	842	450	842	450
Rare Earth Material										
SmCo 18	0.296	8.2	18.0	8700	8000	20000	482	250	1382	750
SmCo 20	0.296	8.2	20.0	9000	8500	15000	482	250	1382	750
SmCo 24	0.304	8.4	24.0	10200	9200	18000	572	300	1517	825
SmCo 26	0.304	8.4	26.0	10500	9000	11000	572	300	1517	825
Neodymium 27	0.267	7.4	27.0	10800	9300	11000	176	80	536	280
Neodymium 27H	0.267	7.4	27.0	10800	9800	17000	212	100	572	300
Neodymium 30	0.267	7.4	30.0	11000	10000	18000	176	80	536	280
Neodymium 30H	0.267	7.4	30.0	11000	10500	17000	212	100	572	300
Neodymium 35	0.267	7.4	35.0	12300	10500	12000	176	80	536	280

* = All magnetic materials demonstrate reversible strength loss as they approach Maximum Operating Temperature.

• Note: Unshielded open circuit ceramic magnets should not be subjected to more than 400°F.

Temperature	Length	Weight	Density
$F^{\circ} = (C^{\circ} \times 1.8) + 32$ $C^{\circ} = \frac{F^{\circ} - 32}{1.8}$	in = cm x .3937 in = mm x .03937 cm = in x 2.54 mm = in x 25.4	$MASS = DNSTY \times VOLUME$ lbs = kg x 2.2046 lbs = g x .0022 kg = lbs x .4536 g = lbs x 453.6	$lbs / in^3 = g / cm^3 \times .03613$ $g / cm^3 = \frac{lbs / in^3}{.03613}$

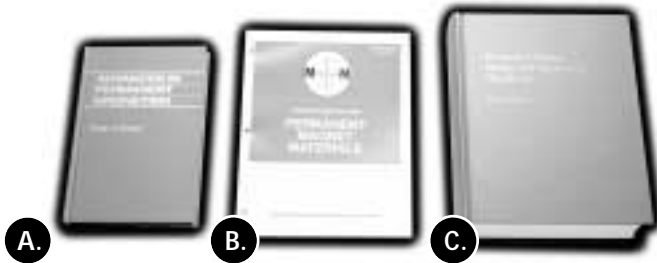

A. Advances in Permanent Magnetism - by Rollin J. Parker, is a 377-page hardcover technical guide that discusses many practical aspects of permanent magnets for electrical and design engineers confronted with design problems involving permanent magnets. Copyright 1990.
Part No. BKAPM

B. MMPA Standard Specifications for Permanent Magnet Materials - This 32-page pamphlet is an extensive guide to the standards of magnets, thermal, physical, and mechanical properties of permanent magnet materials, set forth by the Magnet Materials Producers Association.
Part No. LIT-MMPA

C. Permanent Magnet Design and Application Handbook - by Lester R. Moskowitz, is a 443-page hardcover book on magnets for engineers, inventors, scientists, teachers and students who have a general technical background, but no specific background in magnets, metallurgy or electricity. It covers the history, comparison and applications of, and sources for, magnets, as well as design methods, measurement and testing, and typical circuit effects. Copyright 1976, 1995.
Part No. BKPMDA

Glossary

Anisotropic (oriented) The material has a preferred direction of magnetic orientation.

Coercive Force, H_c - The demagnetizing force, in oersteds, required to reduce the residual induction, B_r , of a fully magnetized magnet to zero.

Curie Temperature - Temperature at which a material loses its magnetic properties.

Gauss - Unit of measure of magnetic induction, B , or flux density in the CGS system.

Gaussmeter - An instrument used to measure the instantaneous value of magnetic induction, B .

Intrinsic Coercive Force, H_{ci} - Oersted measurement of the material's inherent ability to resist self-demagnetization.

Isotropic (non-oriented) - The material has no preferred direction of magnetic orientation, which allows magnetization in any direction.

Magnetic Induction, B - Flux per unit area of a section normal to the direction of the magnetic path. Measured in gauss.

Maximum Energy Product, BH_{max} - The maximum product of ($BdHd$) which can be obtained on the demagnetization curve.

Maximum Operating Temperature - The maximum temperature of exposure that a magnet can forego without significant long-range instability or structural changes.

North Pole - That magnetic pole which attracts the geographic North pole.

Residual Induction, B_r - Flux density, measured in gauss, of a magnetic material after being fully magnetized in a closed circuit.

Other Catalogs

Magnetic Devices - A catalog of magnetic assemblies used for material handling, lifting, holding, retrieving, separating and more!

Flexible Magnets - A catalog of magnetic sheeting and strip used in ad specialties, signmaking, screenprinting, crafts, manufacturing, offices and more!

Consumer products - Several brochures of retail packaged magnets for craft, hardware, office, educational, toys and more!

U.S.A. and International

MASTER MAGNETICS, INC.

607 S. Gilbert St., Castle Rock, CO 80104

Toll Free: 1.800.525.3536

Local: 303.688.3966

FAX: 303.688.5303

California and Hawaii

A-L-L MAGNETICS, INC.

2831 Via Martens, Anaheim CA 92806

Toll Free: 1.800.262.4638

Local: 714.632.1754

FAX: 714.632.1757

Southeastern U.S.

MIAMI MAGNET CO.

6073 NW 167th St., Ste. C26, Miami FL 33015

Toll Free: 1.800.222.7846

Local: 305.823.0641

FAX: 305.823.1603

Copyright © 1999 by MMI.

All Rights Reserved.

\$1.00

LIT-PMM-12/99

